

REVIEW

Alkylation of N-substituted 2-phenylacetamides

DUŠAN Ž. MIJIN^{1#}, MILICA M. MIŠIĆ-VUKOVIĆ^{1#} and SLOBODAN D. PETROVIĆ^{1,2#}

¹Department of Organic Chemistry, Faculty of Technology and Metallurgy, University of Belgrade, P. O. Box 3503, 11120 Belgrade and ²Hemofarm group, Beogradski put bb, Vršac, Serbia and Montenegro

(Received 24 February 2004)

Abstract: Various N-substituted phenylacetamides were alkylated using different alkylating agents under neutral and basic conditions. Reactions were performed at different reaction temperatures and in various solvents. Also, a number of various catalysts were used including phase-transfer catalysts. Reactions were followed using GC or GC-MS technique and the presence as well as the yields of the alkylation products were established. Generally, the best yield and high selectivity in the studied reactions were achieved under basic conditions where in the certain cases some products, mostly N-product, were obtained solely in quantitative yields.

Keywords: alkylation, amides, phenylacetamides, alkylation under neutral conditions, alkylation under basic conditions, phase-transfer conditions.

CONTENTS

1. Introduction
2. Alkylation under neutral conditions
3. Alkylation under basic conditions
4. Alkylation under phase-transfer conditions
5. Further investigations

1. INTRODUCTION

The amide bond represents a bond which participates in the structure of many biologically active compounds, such as proteins, hormones, anesthetics, various penicillic antibiotics, *etc.* Also, the amide bond can be found in many products of the organic chemical industry, such as synthetic polymers, pesticides, drugs, *etc.*

The behaviour of the amide bond is mainly influenced by the reactivity of all three atoms in the O–C–N chain, arising mainly from delocalization of the π electrons along the chain. On the other hand, the chemistry of amides is simplified knowing that the great majority of their reactions proceed by one or two processes. The first involves nucleophilic at-

Serbian Chemical Society active member.

tack by the oxygen or nitrogen atom on electrophilic centres in either positively charged or neutral species. The second, and less common process, involves addition to the carbonyl moiety.¹

It is known that amides are relatively weak bases (with pK_a values lower by approximately 10 units than those of similar amines) and that protonation takes place on the oxygen atom (Fig. 1). Amides in the neutral form react only with more powerful electrophilic reagents and initially form O-substituted derivatives. N-substituted products are the result of rearrangement of O- to N-products. Direct substitution at the nitrogen atom occurs only in special circumstances: either with powerful electrophilic species, such as diazomethane, or under strongly alkaline or acidic conditions where the reactive species are the anion or the conjugate acid of the amide as respective intermediates (Fig. 2).¹

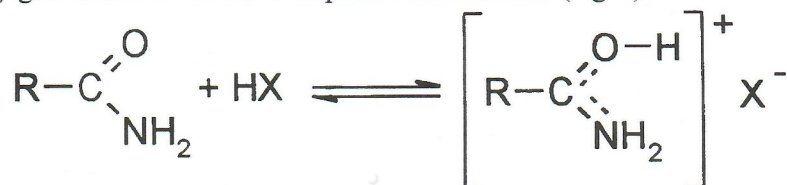

Fig. 1. Protonation of amides



Fig. 2. The anion (I) and the conjugate acid (II) of the amide.

The behaviour of amides towards many reagents often depends on the specific structure of either the acyl (RCO) or the amino part ($-\text{NR}_1\text{R}_2$) of the molecule. In this review, R denotes a benzyl group while R_1 and R_2 vary depending on the structure of the starting amide and alkylating reagents. Conventionally, the carbon atom directly attached to the carbonyl group is referred to as the $\alpha_{\text{C=O}}$ atom, and that directly attached to the nitrogen atom as the α_{N} atom.

Amides take part in various reactions, including alkylation, acylation, halogenation, nitrosation and nitration, oxidation, reduction, hydrolysis and solvolysis. N-substituted 2-phenylacetamides (SPAs) are very interesting compounds because of their structural similarity to the lateral chain of natural benzylpenicillin.² Selective O-alkylation of N-substituted 2-phenylacetamides is of practical importance in penicillin chemistry, not only for use in chemical transformations of natural benzylpenicillin into 6-aminopenicillanic acid, but also because of the possibility of direct transformation of the imino ether into a new semisynthetic penicillin. On the other hand, N-alkylation yields N,N-disubstituted 2-phenylacetamides, important intermediates in the production of herbicides and tertiary amines. The majority of our investigations have been confined to alkylation reactions under neutral and basic conditions of various N-substituted 2-phenylacetamides.

2. ALKYLATION UNDER NEUTRAL CONDITIONS

Amides are present in their unionised form when they are alkylated under neutral conditions. Usually these reactions proceed in aprotic solvents. Only agents more reactive than alkyl halides, such as alkyl sulphates, oxonium salts and diazoalkanes, are useful from the synthetic point of view. The formed products (O- and N-products), are the result of either direct substitution or rearrangement. The ratio of O- and N-alkylation depends on the reaction conditions, such as the reaction temperature and the reactivity of the alkylating agent.

Alkylation with diazomethane³

Diazomethane is a very powerful electrophilic reagent which is capable of reacting readily with most amides, including N-substituted 2-phenylacetamides. The methylation of various N-substituted 2-phenylacetamides (methyl, ethyl, *n*-propyl, *n*-butyl, *n*-pentyl, *n*-hexyl, *i*-propyl, *s*-butyl, 1,2,2-trimethylpropyl, 1-phenylethyl, cyclopropyl, cyclobutyl, cyclopentyl, cyclohexyl, phenyl, 2-naphthyl, 4-methylphenyl, 4-nitrophenyl, 4-bromophenyl, 4-chlorophenyl, 4-(*N,N*-diethylamino)phenyl, 4-methoxycarbonylphenyl and 4-acetylphenyl) leads to formation of a mixture of both O- and N-methylated products according to Scheme 1.

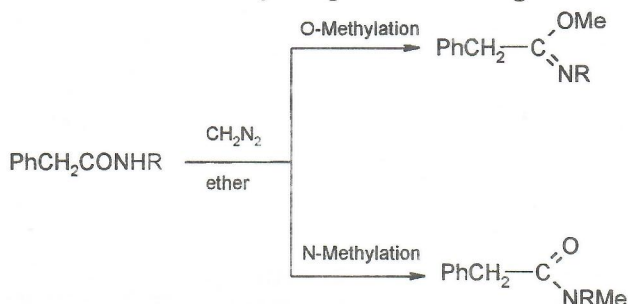

Scheme 1. Alkylation of N-substituted 2-phenylacetamides with ethereal diazomethane solution.

The best conversions were achieved in the molecules of *N*-methyl and *N*-ethyl-2-phenylacetamides (Table I). In the series of *N-n*-alkyl-2-phenylacetamides it is evident that increasing the length of the hydrocarbon chain decreases the conversion. The presence of cycloalkyl groups and alkyl groups with a branched chain as the substituent also decreases the conversion. It was not possible to establish the influence of substituents in position 4 of the phenyl ring in the *N*-phenyl substituted 2-phenylacetamides from the obtained results (Table I).

The N/O-ratio of the alkylation products shows the formation of methyl phenylacetate on the basis of GC-MS investigations. The possible reaction pathways for the formation of methyl phenylacetate are given in Scheme 2.

From the obtained results, it could be concluded that diazomethane, as a very strong electrophilic reagent, is unselective in the alkylation of the investigated series of N-substituted 2-phenylacetamides.

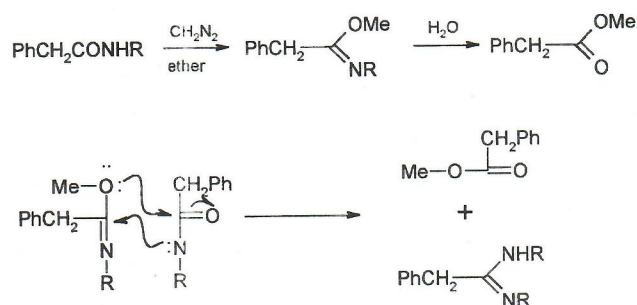

Scheme 2. Possible reaction pathways for the formation of methyl phenylacetate from N-substituted 2-phenylacetamides.

TABLE I. Alkylation of N-substituted 2-phenylacetamides with ethereal diazomethane solution

Substituent	Conditions	SPA/%	N-product/%	O-product/%	Methylphenylacetate/%
Methyl	A/B	58.2/29.8	6.2/10.4	22.5/3.10	12.7/56.35
Ethyl	A/B	79.8/64.97	5.3/3.5	9.7/0.15	5.1/31.13
<i>n</i> -Propyl	A/B	85.3/76.98	4.1/10.23	8.6/-	1.8/10.59
<i>n</i> -Butyl	A/B	84.7/78.3	4.5/11.85	9.9/0.31	0.59/9.23
<i>n</i> -Pentyl	A/B	87.1/83.4	3.8/9.54	7.8/0.42	1.2/6.48
<i>n</i> -Hexyl	A/B	90.8/79.5	3.6/8.83	4.7/1.02	0.7/10.5
<i>i</i> -Propyl	B	95.26	4.38	0.30	
<i>s</i> -Butyl	B	96.55	2.52	0.63	
1,2,2-Trimethylpropyl	B	97.50	1.57	0.80	
1-Phenylethyl	B	93.30	2.12	4.20	
Cyclopropyl	B	99.04	0.94		
Cyclobutyl	B	97.02	2.68		
Cyclopentyl	B	96.46	1.80		
Cyclohexyl	A/B	94.74/92.80	2.53/2.78	2.73/1.37	-/3.05
Phenyl	A/B	100/94.12	-/5.86		
4-Methylphenyl	B	82.82	11.62	5.56	
4-Methoxyphenyl	B	93.85	6.15		
4-Nitrophenyl	A/B	92.82/60.62	7.17/25.70	-/12.4	-/1.1
4-Chlorophenyl	B	95.4	3.9	0.6	
4-Acetylphenyl	B	99.3	0.6		

A – ethereal diazomethane solution, anhydrous, reaction time 4 h, reaction temperature 20–25 °C; B – ethereal diazomethane solution, without drying, reaction time 12 h, followed by standing at 20–25 °C for 12 h.

Alkylation of N-substituted 2-phenylacetamides with methyl and ethyl iodide⁴

When N-substituted 2-phenylacetamides (methyl, ethyl, *n*-propyl, *n*-butyl, *n*-pentyl, *n*-hexyl, *i*-propyl, cyclohexyl and phenyl) are alkylated with methyl and ethyl iodide in the presence or in the absence of a catalyst (Ag₂O) at different temperatures, N- and O-products of alkylation were detected using GC-MS (Scheme 3).

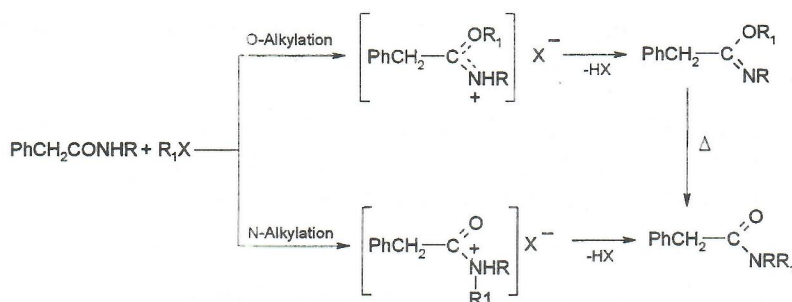

Scheme 3. Alkylation of N-substituted 2-phenylacetamides with methyl and ethyl iodide.

On the basis of the obtained data it was concluded that, in general, the conversion was low (Table II). Besides, the alkylation reaction of *N-n*-alkyl-2-phenylacetamides with methyl iodide proceeds only in the presence of a catalyst. The transformation takes place to a considerably higher degree if it proceeds at elevated temperatures and prolonged reaction times. It was also found that the size of the alkyl group does not influence the degree of conversion. Besides N- and O-product of alkylation, methyl phenylacetate was also formed. Considering the selectivity, no regularity could be established in the obtained results.

TABLE II. Alkylation of N-substituted 2-phenylacetamides with methyl and ethyl iodide in the presence of Ag₂O

Alkyl iodide	Substituent	Conditions	SPA/%	N-product/%	O-product/%	Alkyl phenylacetate/%
Methyl	Methyl	A/B	96.2/80.2	1.2/9.3	-/1.2	1.8/4.5
	Ethyl	A/B	94.1/67.3	1.5/7.6	-/8.3	99/12.6
	<i>n</i> -Propyl	A/B	85.3/72.0	-/1.3	-/0.8	0.5/7.2
	<i>n</i> -Butyl	A/B	98.7/80.2	-/1.3	-/0.8	0.5/7.2
	<i>n</i> -Pentyl	A/B	-/2.4	-/3.9	-/13.8	-/4.6
	<i>n</i> -Hexyl	A/B	1.9/11.2	-/3.6	2.7/14.1	0.6/14.9
	<i>i</i> -Propyl	B	4.8	3.5	12.1	1.3
	Cyclohexyl	B	68.2	11.7	5.5	9.8
	Phenyl	B	71.6	94.4	7.8	3.9
	Ethyl	Ethyl	A/B	98.3/82.2	0.7/5.8	-/2.3
<i>i</i> -Propyl		B	87.6	3.3	1.7	3.5
cyclohexyl		B	85.2	3.8		4.2
Phenyl		B	82.5	4.3		5.3

Mole ratio amide: alkyl iodide = 1:2; A – reaction time 4 h, reaction temperature 20–25 °C; B – reaction time 2 h, reflux.

In the alkylation reaction of N-substituted 2-phenylacetamides with ethyl iodide, the conversions were lower than with methyl iodide under the same reaction conditions (Table II). The existence of significant quantities of N,N-disubstituted 2-phenylacetamides (with both alkyl iodides) can be explained by the fact that many imidate bases can rearrange to N,N-disubstituted 2-phenylacetamides, especially on heating.⁵

Although ten-fold excesses of methyl and ethyl iodide were used, the transformation of the amides to any appreciable percent was unsuccessful, even at reflux conditions, in the absence of catalyst.

The alkylation of N-substituted 2-phenylacetamides with methyl and ethyl iodide under neutral conditions generally gives a mixture of O- and N-alkylated products and from the preparative standpoint the reaction is of limited importance.

Alkylation with dimethyl and diethyl sulphate⁶

Alkylation of N-substituted 2-phenylacetamides (methyl, ethyl, *n*-propyl, *n*-hexyl, *i*-propyl, cyclohexyl, phenyl) with two equivalents of dimethyl and diethyl sulphate was carried out at 20–25 °C and at reflux temperature, and the reaction mixtures were analyzed using GC/MS and/or by comparison with authentic samples. With dimethyl sulphate the conversions are relatively high as shown by the low percent of initial compounds in the final reaction mixtures (close to 100 %, Table III). The highest conversion was obtained with the smallest molecules. It is evident that in the series of *N*-(*n*-alkyl)-2-phenylacetamides, increasing the length of the hydrocarbon chain decreased the conversion. The nucleophilic reactivity of neutral amides resides at the oxygen atom. On the other hand, the existence of appreciable quantities of N,N-disubstituted 2-phenylacetamides can be explained by the fact that many N-alkylimidates can transform to N,N-disubstituted amides by the Chapman rearrangement.^{7,8}

TABLE III. Alkylation of N-substituted 2-phenylacetamides with dimethyl and diethyl sulphate

Dialkyl sulphate	Substituent	Conditions	Conversion/%	N-product/%	Alkyl phenylacetate/%
Methyl	Methyl	A/B	91.9/100	14.3/17.1	77.6/82.9
	Ethyl	A/B	89.4/100	13.1/16.2	76.3/83.8
	<i>n</i> -Propyl	B	93.8	15.7	78.1
	<i>n</i> -Hexyl	B	88.4	13.6	74.8
	<i>i</i> -Propyl	A/B	85.8/96.4	10.5/21.3	75.3/75.1
	Cyclohexyl	B	82.2	11.5	70.1
	Phenyl	B	81.6	16.3	65.3
	Ethyl	B	100	12.5	87.5
Ethyl	<i>i</i> -Propyl	A/B	91.4/94.1	5.9/8.6	85.5/86.1
	Cyclohexyl	B	89.3	5.8	83.5
	Phenyl	B	87.9	7.6	80.3

Mole ratio amide: dialkyl sulphate = 1:2; A – reaction time 3 h, reaction temperature 20–25 °C; B – reaction time 3 h, reflux.

The conversion in the alkylation of N-substituted 2-phenylacetamides (ethyl, *i*-propyl, cyclohexyl, phenyl) with two equivalents of diethyl sulphate is slightly higher than that with dimethyl sulphate under the same experimental conditions (Table III). The existence of higher quantities of ethyl phenylacetate and slightly higher quantities of the N-methyl derivative suggest that compounds which have a methyl group attached to the oxygen atom rearrange faster than the O-ethyl analogues.

The major products in this reactions are O-alkyl derivatives. According to the obtained results, the reaction pathway shown in Scheme 4 was proposed. The attack proceeds preferentially at the O-atom, to give the more stable intermediate, which can be transformed later into O- or N-products. Thus, O-alkyl (methyl or ethyl) N-substituted 2-phenylacetamides are kinetic products and N-alkyl (methyl or ethyl) N-substituted 2-phenylacetamides are the thermodynamically stable ones.⁵ The second possibility, *i.e.*, a direct N-attack seems much less reasonable.

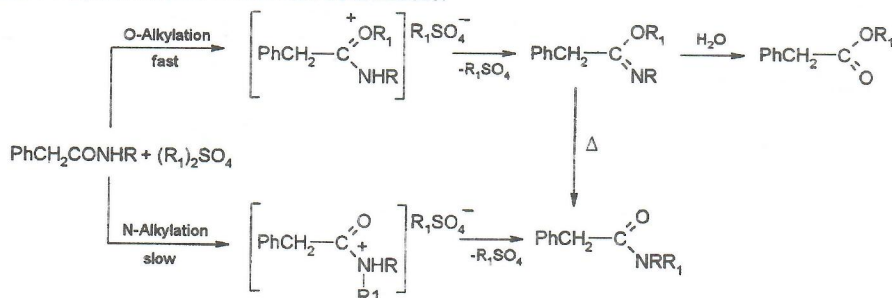

Scheme 4. Alkylation of N-substituted 2-phenylacetamides with dimethyl and diethyl sulphate.

Although a certain selectivity was observed in the alkylation reactions, it is necessary to note that synthetically important regiospecific alkylation of the studied amides with dialkyl sulfates may be relatively difficult to achieve.

Alkylation with trialkyloxonium salts⁹

Trialkyloxonium salts are powerful alkylating agents. Trimethyl and triethyloxonium tetrafluoroborates, in particular, have been widely employed for the methylation and ethylation of sensitive or weakly nucleophilic functional groups, including the amide group.¹⁰ The oxygen atom of amides can be alkylated by oxonium salts to give salts of N-alkyliminoethers.¹¹

N-Substituted 2-phenylacetamides (ethyl, *n*-propyl, *i*-propyl, *n*-butyl, cyclohexyl) were treated with trimethyloxonium tetrafluoroborate under ambient conditions (Scheme 5) and the products were analysed by GC.

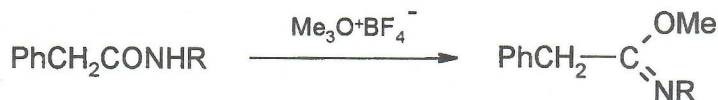

Scheme 5. Alkylation of N-substituted 2-phenylacetamides with trimethyloxonium tetrafluoroborate.

On the basis of the obtained data, it was concluded that the conversion was relatively low regarding the high percent of starting compounds in the final reaction mixtures (Table IV). The nucleophilic attack proceeds at the oxygen atom. The existence of N-alkylated products was not confirmed in any of the investigated reactions.

In addition, N-substituted 2-phenylacetamides (*n*-propyl, *i*-propyl, cyclohexyl, phenyl) were treated with triethyloxonium tetrafluoroborate under the same conditions as above (Scheme 6).

TABLE IV. Alkylation of N-substituted 2-phenylacetamides with trimethyl and triethyloxonium tetrafluoroborate

Trialkyloxonium tetrafluoroborate	Substituent	Conditions	SPA/%	N-product/%	Alkyl phenylacetate/%
Methyl	Ethyl	A/B	89.4/80.4	9.0/14.2	1.6/5.4
	<i>n</i> -Propyl	A	83.3	15.9	0.80
	<i>i</i> -Propyl	A/B	71.0/62.4	16.6/28.7	12.4/8.9
	Cyclohexyl	A/B	78.6/72.8	15.0/23.8	6.4/3.4
	<i>n</i> -Propyl	A/C	76.3/59.3	21/33.4	2.7/7.3
Ethyl	<i>n</i> -Propyl	A*/C*	47.4/39.2	45/55.4	7.6/5.4
		A/C	85.7/72.7	10.4/22.8	4.4/4.5
	Cyclohexyl	A*/C*	22.6/30.5	60.6/60.4	16.8/9.1
		A/C	75.2/78.6	22.6/20.4	2.2/1.0
	Phenyl	A*/C*	3.6/22.6	84/62	12.4/15.4
		A/C	79.6/72.8	16.0/9.1	4.4/18.1
		A*/C*	67.7/45.6	24.0/2.2	8.3/52.2

A – Mole ratio amide: trialkyloxonium tetrafluoroborate = 1:1, reaction time 1 h, reaction temperature 20–25 °C; B – Mole ratio amide: trialkyloxonium tetrafluoroborate = 1:1, reaction time 4 h, reaction temperature 20–25 °C; C – Mole ratio amide: trialkyloxonium tetrafluoroborate = 1.2, reaction time 1 h, reaction temperature 20–25 °C; A* – Mole ratio amide: trialkyloxonium tetrafluoroborate = 1:1, reaction time 24 h, reaction temperature 20–25 °C; C* – Mole ratio amide: trialkyloxonium tetrafluoroborate = 1:2, reaction time 24 h, reaction temperature 20–25 °C

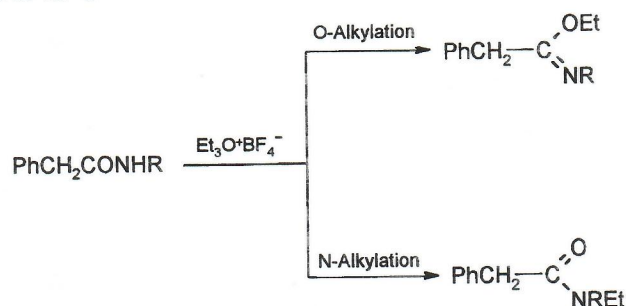

Scheme 6. Alkylation of N-substituted 2-phenylacetamides with triethyloxonium tetrafluoroborate.

The conversion in the alkylation reaction with triethyloxonium tetrafluoroborate is higher than in the reaction with trimethyloxonium tetrafluoroborate under the same reaction conditions (Table IV). A prolonged reaction time and a two-fold excess of the oxonium salt increase the conversion of the starting amides up to 94.4 %. The major products are N-ethyl derivatives. The existence of appreciable quantities of ethyl phenylacetate suggests that the alkylation took place at both the O- and N-atom. The used reagents are unselective in the investigated reactions or, if they were selective, very low conversions were achieved.

*Alkylation with methyl trifluoromethanesulfonate*¹²

Methyl trifluoromethanesulfonate has been used previously as a methylating agent, in the alkylation of various weak nucleophiles.¹³ Alkylation of various amides by methyl fluorosulfonate leads to O-alkylated products.¹⁴ In our study of the alkylation of N-substituted 2-phenylacetamides, the alkylation of certain N-substituted 2-phenylacetamides (ethyl, *n*-propyl, *i*-propyl, *n*-butyl, cyclohexyl) were performed with a five-fold excess of methyl trifluoromethanesulfonate (Scheme 7) and the products were analyzed by GC-MS and/or by comparison with authentic samples.

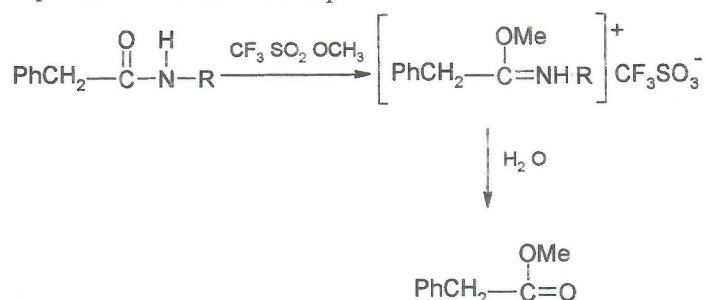

Scheme 7. Alkylation of N-substituted 2-phenylacetamides with methyl trifluoromethanesulfonate.

The high conversions were obtained due to the prolonged reaction time (Table V). The nucleophilic attack proceeds only at the O-atom. The existence of N-methylated products was not confirmed in any of the cases.

TABLE V. Alkylation of N-substituted 2-phenylacetamides with methyl trifluoromethanesulfonate

Substituent	Conditions	SPA/%	Methyl phenylacetate/%
Ethyl	A/B	38.2/2.7	61.8/97.3
<i>n</i> -Propyl	A/B	52.4/15.5	47.6/84.5
<i>i</i> -Propyl	A/B	56.3/17.1	43.7/82.9
<i>n</i> -Butyl	A/B	46.8/13.5	53.2/86.5
Cyclohexyl	A/B	62.8/18.5	37.2/81.5

Mole ratio amide: methylating agent = 1:5; A – reaction time 1 h, reaction temperature 20 °C; B – reaction time 3 h, reaction temperature 20 °C

3. ALKYLATION UNDER BASIC CONDITIONS

Under basic conditions greater control over the site of alkylation can be achieved. Therefore these reactions can be more useful from the synthetic standpoint. Primary and secondary amides in the presence of a strong base normally react at the nitrogen atom.¹ This selectivity can be associated with the formation of the carboxamide anion, after which alkylation of the nitrogen atoms occurs directly. For compounds like phenylacetamides, the enhanced acidity of the $\alpha_{\text{C=O}}$ hydrogens leads to the formation of a carbanion or, with excess base, a dianion. The C-alkylation competes with N-alkylation and with just one equivalent of the alkylating agent, the C-derivative was obtained which indicates that the

carbanion is the most nucleophilic site.¹⁵ Generally, alkylation of N-substituted 2-phenylacetamides under basic conditions can proceed as shown in Scheme 8 in which the theoretically possible reaction products are given.

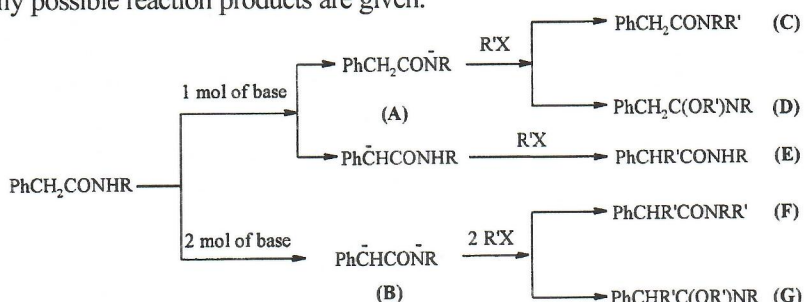

Scheme 8. Alkylation of N-substituted 2-phenylacetamides under basic conditions ((A)-monoanions, (B)-dianion, (C)-N-product, (D)-O-product, (E)-C-product, (F)-C,N-product, (G)-C,O-product).

Among other compounds, Sukata¹⁶ alkylated amides and phenylacetamides, using different alkyl halides (ethyl, *n*-butyl, allyl and benzyl bromide) in the presence of alumina and KOH. Selective N-monoalkylations were achieved (from 80–97.5%) but GC analysis showed that there were some other products besides the N-product.¹⁶

Alkylation of N-ethyl-2-phenylacetamide¹⁷

When N-ethyl-2-phenylacetamide (EPA) was alkylated with one equivalent of benzyl chloride at low temperature (30 °C and 60 °C), N-alkylation predominated over C-alkylation (Fig. 3). At higher temperatures, though N-alkylation was still predominant, a C,N-product besides the C-product was detected when one equivalent of alkylating reagent was used (Fig. 4). A small steric hindrance of the ethyl group on the nitrogen atom could be the reason why the N-product predominates. C,N-alkylation could be the result of two factors: high reaction temperature which permits further alkylation of the N- and C-products and the very reactive alkylating reagent, benzyl chloride. The O-product was not detected under these reaction conditions.

Increasing the amount of benzyl chloride compared to the amide and KOH, increases the number of alkylation products. Except for the N-product, which was formed in all experiments, C- and O-products were formed when a large excess of the alkylating agent (15 fold excess) was present in the reaction mixture.

Increasing the concentration of solid KOH in the reaction mixture increases the overall yield and the number of the products. It is obvious that a higher initial amount of the base increases the concentration of the reacting anion, providing for C- and C,N-alkylation besides N-alkylation. In the presence of a very large excess of KOH, the C-product becomes the main alkylation product.

Even when EPA was alkylated in the presence of a large excess of NaOH, the extent of alkylation was smaller compared to alkylation under the same conditions with KOH. Besides C- and N-products, which were formed in the presence of KOH, O- and C,N-products were formed in the presence of NaOH.

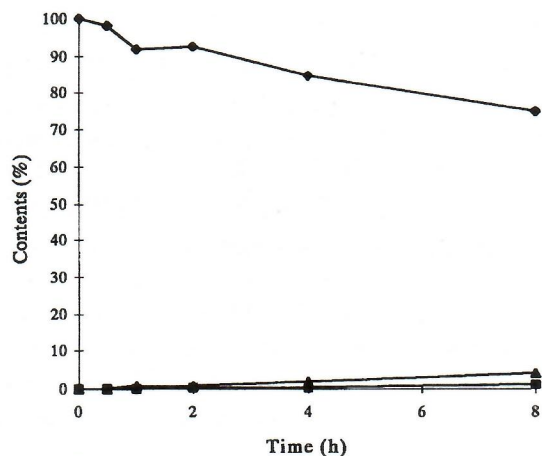

Fig. 3. Alkylation of EPA with benzyl chloride at 60 °C in the presence of KOH in toluene (equimolar amounts of reactants; \blacklozenge – EPA, \blacksquare – C-product; \blacktriangle – N-product).

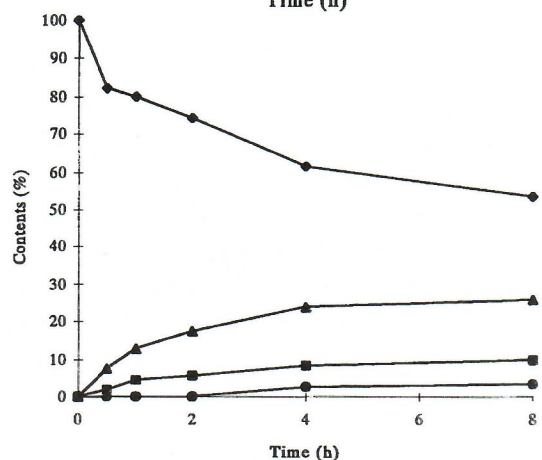

Fig. 4. Alkylation of EPA with benzyl chloride at reflux temperature in the presence of KOH in toluene (equimolar amounts of reactants; \blacklozenge – EPA; \blacksquare – C-product; \blacktriangle – N-product; \bullet – C,N-product).

When EPA was alkylated with two other benzyl halides ($X = \text{Br}, \text{I}$) under the same reaction conditions, no O-product was detected. The C,N-product was found only when benzyl bromide was the alkylating agent. On the basis of the EPA consumed in the reaction, the reactivity of benzyl halides was: benzyl bromide > benzyl iodide \gg benzyl chloride. Obviously, the chloride anion is a poor leaving group, while bromide and iodide anions suited the reaction well. Although alkylation with benzyl bromide yields all three products (C-, N- and C,N-products) whereas alkylation with benzyl iodide or chloride yields two products (C- and N-products), it also gave more by-products than the other two halides.

Five different solvents were used to ascertain the effect of the solvent on the alkylation of EPA with benzyl chloride: toluene, hexane, DMSO, dioxane and isooctane. The O-product was formed rarely (only in hexane and dioxane at the solvent reflux). Nonpolar solvents favor the formation of the N-product. The best solvent for the formation of the C-product was DMSO. Evidently, there is no pure O-, C-, N- or C,N-alkylation in the solvents used.

*Alkylation of N-phenyl-2-phenylacetamide*¹⁸

The alkylation of *N*-phenyl-2-phenylacetamide (PPA) with benzyl chloride in the presence of powdered potassium hydroxide in the solid-liquid system was carried out. Contrary to the literature,¹⁵ no C-product was formed. The main product was the N-product, although some O-product was also formed.

The alkylation reactions of PPA were carried out in different solvents at different temperatures using different quantities of reactants. Only the N-product was formed in non-polar solvents. With a two fold excess of potassium hydroxide and benzyl chloride at the reflux temperature an almost quantitative yield of the N-product was obtained in toluene. In polar solvents, the C-product was detected at 60 °C, while at 30 °C the O-product was formed in a larger yield than at 60 °C. No C- or O-product were detected at reflux temperature. As far as the N-product is concerned, nonpolar solvents, high temperature and an excess of base favour the reaction.

The formation of the N-product as the main product in all the reactions and in most of the reactions is the only one, indicate that the most nucleophilic site in a molecule of PPA is not the carbanion center. Viewing the most stable conformation of PPA obtained by the computer program DTMM* (Fig. 5), it can be seen that steric hindrance of the attack of a base on either hydrogens on the nitrogen atom or the hydrogen(s) on the $\alpha_{C=O}$ -carbon atoms does not differ enough to favor the formation of one of the two mono-anions. On this basis, the only way to explain the favoured formation of the N-product is to presume that the acidity of the hydrogen on nitrogen atom is much greater than the acidity of the hydrogen(s) on the $\alpha_{C=O}$ -carbon atoms. Finally, it can be concluded that the most nucleophilic site in the PPA molecule is the nitroanion center.

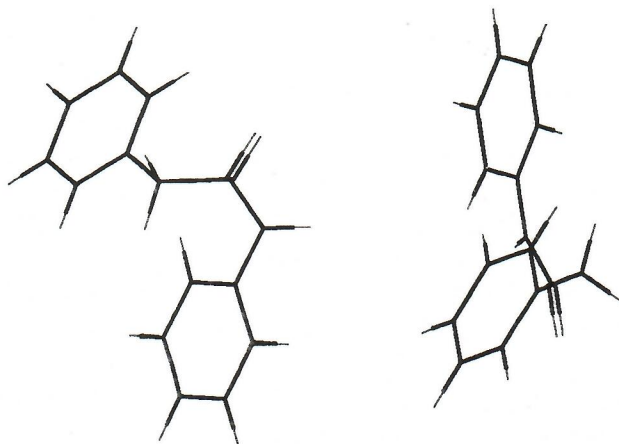

Fig. 5. Two views of the most stable conformation of PPA showing the susceptibility to base attack on either the hydrogen on the nitrogen atom or the hydrogen(s) on the $\alpha_{C=O}$ -carbon atoms.

* Desktop Molecular Modeller, version 2.0 by M.J.C. Crabbe & J.R. Appleyars, Polyhedron Software Ltd, Oxford University Press, 1991

*Alkylation of N-benzyl-2-phenylacetamide*¹⁹

The alkylation reactions of *N*-benzyl-2-phenylacetamide (BPA) were carried out in different solvents at different temperatures. In non-polar solvents, in almost all cases, only the N-product was formed. In the polar basic solvent DMSO, in addition to the N-product, which was the main product, both the C-product and the O-product were formed. Increasing the temperature lowers the reactivity of BPA, and the yield of the products, especially of the N-product, was lower due to a decreased solvation of the reacting species. Concerning the N-product, nonpolar solvents, high temperatures and excess of base and benzyl chloride favour the reaction. At reflux temperature with an equimolar ratio of the reactants, the highest yields of the N-product were obtained in isooctane and then in toluene, indicating that at high temperatures the less polar solvents favour N-alkylation. With a two fold excess of potassium hydroxide and benzyl chloride at reflux temperature, the yield of the N-product was only 43.37 %.

The low reactivity of *N*-benzyl-2-phenylacetamide (BPA), compared to that of *N*-phenyl-2-phenylacetamide (PPA) and *N*-ethyl-2-phenylacetamide (EPA), can be explained in terms of steric and polar effects. The order of reactivity of these three amides is: PPA > EPA > BPA. Since the N-product is the main product in most of the performed alkylation reactions, the order of reactivity can be explained in terms of the formation of the N-product, the formation of which as the main product in all reactions indicates that the most nucleophilic site in the molecule of N-substituted-2-phenylacetamides is the anion formed by cleavage of the nitrogen hydrogen.¹⁶ As presented in Scheme 9, the nature of the substituent on the nitrogen atom has an important influence on the reactivity of the amide. The formed amide anion is stabilized by resonance with the carbonyl group. If an alkyl group is attached to the nitrogen atom, the positive inductive effect destabilizes the formed anion. An aryl group, if attached to the nitrogen atom, stabilizes the anion by resonance.

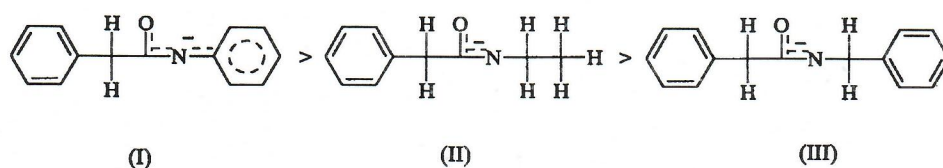

Scheme 9. The order of reactivity – structure of the formed anions of PPA (I), EPA (II) and BPA (III).

Thus, N-substituted-2-phenylacetamides which have an aryl group as substituent are more reactive than the corresponding alkyl substituted compounds because their anions, having a lower energy, are more readily formed. The steric effect is important when the benzyl group is compared to the ethyl group (Scheme 9). Since the benzyl group has no resonance effect, this group being bulkier hinders the substitution reaction. Thus, EPA is more reactive than BPA, but less reactive than PPA.

Alkylation of N-(4-substituted phenyl)-2-phenylacetamides

N-(4-Nitrophenyl)-2-phenylacetamide (NPA) was alkylated with benzyl chloride in the presence of powdered potassium hydroxide in a solid-liquid system.²⁰ The reactions

were performed at 60 °C and at reflux temperature in different solvents. Increasing the initial amount of benzyl chloride at reflux temperature does not increase the reactivity, but increasing the initial amount of potassium hydroxide and of benzyl chloride increases the reactivity up to almost 100 %.

When the orientation in the benzylation reaction of NPA is considered, the ratio of products differs and depends on the reaction conditions. At 60 °C, with equimolar amounts of the reactants, the N-product was the main product in hexane, isooctane, toluene and DMSO. The same is true in toluene at reflux temperature, with equimolar amounts of reactants and with an excess of benzyl chloride. The O-product was detected in every experiment even at the reflux temperature. The C-product was also detected in almost all the experiments except when low reactivity of NPA was observed, such as in dioxane and toluene at 60 °C. At the reflux temperature with excess benzyl chloride in toluene, the C-product became the main product.

Compared to *N*-phenyl-2-phenylacetamide, it would be expected that *N*-(4-nitrophenyl)-2-phenylacetamide should be more reactive since the nitro group as an electron-acceptor group, by both inductive and resonance effects, favours the formation of the corresponding anion. That was true for the reactions performed at 60 °C in toluene, hexane, isooctane, but the reactivity at reflux temperature in toluene is inverted. This change in reactivity could be explained by a decrease of the nucleophilicity of the formed anion through resonance.

On the other hand, the selectivity is lower with NPA than with PPA. The reason might be the same. When PPA reacts, the most nucleophilic site in the molecule is nitrogen. However, the nitrogen in NPA is less nucleophilic because of resonance and the other reactive centers, *i.e.*, the α -carbon and oxygen, are thus more favored, which led to a less selective alkylation. Under very basic conditions (excess of potassium hydroxide), the $\alpha_{C=O}$ carbon is the most nucleophilic site, which is consistent with the result of the alkylation of PPA under very basic conditions (NaNH_2).¹⁵

N-(4-chlorophenyl)-2-phenylacetamide (CPA) was also alkylated with benzyl chloride.²¹ The reactions were also performed at 60 °C and at reflux temperature in different solvents. In polar solvents, such as DMSO, the reactivity of CPA is increased in comparison with its reactivity in toluene. Increasing the initial amounts of potassium hydroxide and benzyl chloride increased the reactivity of CPA up to almost 100 %.

As for the orientation in the reaction of benzylation of CPA, the N-product was the main product under all experimental conditions. The highest reactivity in DMSO at 60 °C led to the yield of the N-product being higher in DMSO than in the other solvents. On the other hand, the selectivity was lower in DMSO since besides the N-product, O- and C-products were also formed.

At reflux temperature, especially in the presence of higher initial amounts of potassium hydroxide and benzyl chloride, the reactivities of CPA and PPA were almost identical. On the other hand, at 60 °C NPA was more reactive than PPA but less reactive than CPA. The NPA anion should be formed easier than the CPA anion, but it seems that the CPA anion reacts faster than the NPA anion due to delocalization of the negative charge in

the latter and also because of the positive resonance effect of the chlorine atom, both of which influence the nucleophilicity of the reacting anions. The selectivity of CPA in the benzylation reaction was higher in comparison to NPA,²⁰ and was the same as PPA.¹⁸

N-(4-Methylphenyl)-2-phenylacetamide (MPA) and *N*-(4-methoxyphenyl)-2-phenylacetamide (MetPA) were also alkylated with benzyl chloride in the presence of powdered potassium hydroxide in the solid-liquid system.²² The reactions were performed at 60 °C and at reflux temperatures in different solvents. When the methyl group was the substituent, at 60 °C, with equimolar amounts of reactants, in hexane, isooctane and dioxane, the reactivity was found to be very small. The reactivity increased in toluene and in dimethyl sulfoxide (DMSO). As far as the orientation of the benzylation of MPA is concerned, the N-product was the main product in all solvents. The O-product was also detected but in minor quantities. The C-product was detected only in DMSO.

When the methoxy group was introduced in position 4 of N-phenyl group of N-substituted 2-phenylacetamide, at 60 °C, with equimolar amounts of reactants, in hexane, isooctane, toluene and dioxane, the reactivity of MetPA was found to be less than 9 %. Only in DMSO was the reactivity high (more than 76 %).

When the initial amounts of benzyl chloride and potassium hydroxide were increased, the reactivity of MetPA was almost 100 %. The main product in all experiments was also the N-product, although some O-product was detected. The C-product was detected once again only in DMSO.

When *N*-(4-substituted phenyl)-2-phenylacetamides were alkylated under basic conditions, an anion was formed first, when the amounts of base and amide were the same. The formed anion then participates in the substitution reaction with an alkyl halide. It seems that the reactivity of the investigated *N*-(4-substituted phenyl)-2-phenylacetamides is influenced by the reactivity of the formed anion (rate determining or slow step) rather than its formation (fast step).

Table VI summarizes the results of the alkylation of *N*-substituted 2-phenylacetamides with benzyl chloride under basic conditions.

TABLE VI. Alkylation of *N*-substituted 2-phenylacetamides with benzyl halide under basic conditions (amount of SPA 5 mmol, reaction time 4 h, volume of solvent 10 ml)

Substituent	Solvent	Conditions	SPA %	N-product %	C-product %	C,N-product %	O-product %
		A	80.23	1.62	0.54		
		B	82.65	6.09	1.29		
	Toluene	C	73.66	4.81	0.55		
		D	1.11	23.98	4.17	63.35	
		E	61.48	24.05	8.47	2.63	
	Hexane	C	39.48	20.47	2.50	1.64	
		D	4.57	32.33	8.13		

TABLE VI. Continued

Substituent	Solvent	Conditions	SPA %	N-product %	C-product %	C,N-product %	O-product %
Ethyl ¹⁷	DMSO	C	28.12	5.85	13.82	9.59	
		D	49.00	6.76	2.99	0.37	
	Dioxane	C	93.64	0.23	0.42		
		D	84.67	0.99	0.39		0.59
	Isooctane	D	29.07	35.46	7.77	16.94	
	Hexane	C*	82.50	13.79			
	Isooctane	C*	92.38	7.31			
		A*	96.86	3.14			
		C*	85.41	11.97			2.12
		Toluene	E*	20.65	78.78		
F				89.09			
G				98.98			
Dioxane	A*	76.24	1.52				
	A*	42.13	33.93			18.91	
DMSO	C*	30.25	51.08	2.68		5.49	
	E*	62.19	28.12				
Isooctane	E*	57.70	41.18				
	C*	98.17					
Benzyl ¹⁹	Toluene	E*	82.40	16.66			
		F	69.82	27.92			
		G	54.42	43.37			
	DMSO	A*	69.26	27.63	1.44		0.71
		C*	56.82	22.54	17.50		
		E*	80.99	8.53			1.47
Hexane	C*	55.56	40.87	1.79		0.39	
Isooctane	C*	73.95	21.52	0.53		3.84	
4-Nitrophenyl ²⁰	Toluene	C*	63.98	30.47			6.17
		E*	28.19	29.96	21.88		17.54
		F	33.50	35.33	12.96		16.37
	Dioxane	G	0.81	6.71	70.74		6.79
		C*	93.31	2.80			2.18

TABLE VI. Continued

Substituent	Solvent	Conditions	SPA %	N-product %	C-product %	C,N-product %	O-product %
4-Chlorophenyl ²¹	DMSO	C*	31.32	38.63	13.80		1.57
	Hexane	C*	43.83	54.08			
	Isooctane	C*	51.67	46.39			
		C*	43.09	56.22			
		E*	10.08	89.04			0.02
	Toluene	F	13.60	85.55			0.09
		G	0.04	98.86			0.07
	Dioxane	C*	89.32	7.33			0.41
	DMSO	C*	26.90	64.61	2.05		0.15
	Hexane	C*	91.43	8.44			0.11
4-Methylphenyl ²²	Isooctane	C*	97.15	2.68			
		C*	45.32	54.50			0.04
	Toluene	E*	23.47	76.18			0.13
		F	13.19	86.02			0.20
		G	5.50	92.19			0.61
	Dioxane	C*	94.43	5.44			0.02
	DMSO	C*	24.26	68.33	1.79		0.51
	Hexane	C*	98.73	1.05			0.08
	Isooctane	C*	91.63	6.47			0.10
	4-Methoxyphenyl ²²		C*	93.22	6.49		
Toluene		E*	20.09	79.73			0.04
		F	18.98	80.71			0.11
		G	0.02	99.62			0.07
Dioxane		C*	91.99	7.46			0.05
DMSO		C*	23.80	73.29	1.17		0.11

A – temperature 30 °C, amount of benzyl chloride 5 mmol, amount of sodium hydroxide 5 mmol; B – temperature 30 °C, amount of benzyl chloride 15 mmol, amount of sodium hydroxide 30 mmol; C – temperature 60 °C, amount of benzyl chloride 5 mmol, amount of sodium hydroxide 5 mmol; D – temperature reflux, amount of benzyl chloride 15 mmol, amount of sodium hydroxide 30 mmol; E – temperature reflux, amount of benzyl chloride 5 mmol, amount of sodium hydroxide 5 mmol; C* – same as C, but potassium hydroxide used; A* – same as A, but potassium hydroxide used; E* – same as E, but potassium hydroxide used; F – reflux, amount of benzyl chloride 10 mmol, amount of potassium hydroxide 5 mmol; G – reflux, amount of benzyl chloride 10 mmol, amount of potassium hydroxide 10 mmol.

4. ALKYLATION UNDER PHASE-TRANSFER CONDITIONS

Phase-transfer catalysis (PTC) is an advantageous method in many organic reactions. PTC enables reactions between anions or molecules soluble in one phase with organic substrates soluble in the other phase. The key factor in such PTC systems is the catalyst. The role of the catalysts, which are usually quaternary ammonium salts, is to maintain the presence of reacting anions in the reaction medium.²³

Sukata¹⁶ alkylated phenylacetamide with ethyl, allyl and benzyl bromide under PTC/OH conditions using tetrabutylammonium bromide (TBABr) as the catalyst. The obtained results indicate that the acidity of the C-H bond is similar to that of the N-H bond. The selectivity of N-alkylation was up to 85 % while the conversion was almost complete.¹⁶

Alkylation of N-ethyl-2-phenylacetamide

*Alkylation with n-butyl bromide.*²⁴ When EPA was alkylated with *n*-butyl bromide it was found that the yield of the N-product increases with increasing initial amount of phase-transfer catalyst (up to 10 % mol/mol). Increasing the base concentration increases the yield of the products (except the O-product) and the quantity of reacted EPA. It is obvious that a strong base is necessary for the deprotonation of EPA and that a higher concentration of the base increases the concentration of the reacting anion. The quantity of the base plays a key role in the reaction.

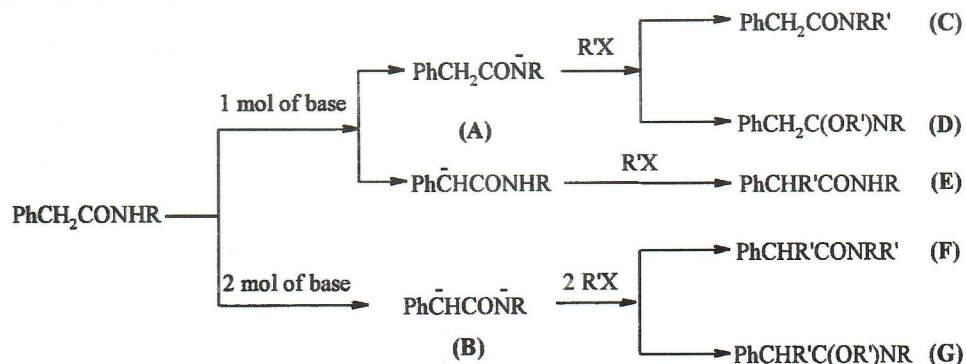

Scheme 10. PTC extraction mechanism for the alkylation of N-substituted phenylacetamides.²⁴

Experiments with an excess of the alkylating agent showed that, except in the case of a slight excess of *n*-butyl bromide, higher quantities have no influence on the reaction.

Six different solvents were used to ascertain the effect of the solvent. The order of activity was found to be: *i*-octane > *n*-hexane > cyclohexane > toluene > THF > dioxane. This was true for N- and C-alkylation, while there was a slight difference for O-alkylation, but the overall picture was the same: *i*-octane > toluene > cyclohexane > *n*-hexane > dioxane > THF. The non polar solvents favour the reaction, while the polar ones hinder it.

Several quaternary ammonium salts, a crown ether, as well as phosphonium and pyridinium salts were applied as catalysts in the reaction under identical conditions. The bigger is the quaternary catalyst quat, Q^+ , the more active is the catalyst in this reaction. This ob-

servation is typical of PTC reactions which take place by the extraction mechanism.²⁵

Two major mechanisms, viz. Starks's extraction mechanism²⁵ and the Makosza's interfacial mechanism²⁶ have been proposed to explain the behavior of PTC systems. According to the principles of determining mechanisms in PTC/OH systems,²³ the PTC alkylation of EPA proceeds by the extraction mechanism, which includes "extraction" of the hydroxide anion into the organic phase where it reacts with the substrate (EPA) producing an active organic anion which, in the substitution reaction with the *n*-butyl bromide, gives the products (Scheme 10). The first step of the proposed mechanism should be the slow one, since the quantity of the base plays a significant role in the reaction.

Table VII summarizes the results of the alkylation of N-substituted 2-phenylacetamides under PTC/OH.

TABLE VII. Alkylation of N-substituted 2-phenylacetamides under PTC/OH (toluene 10 ml, SPA 5 mmol, equimolar ratio of SPA, alkyl halide and potassium hydroxide, catalyst 0.5 mmol, reaction temperature 60 °C, reaction time 2.5 h)

Substituent	Alkyl halide	Catalyst	SPA %	N-product %	C-product %	C,N-product %	O-product %		
Ethyl	<i>n</i> -Butyl bromide ²⁴	TEABr	65.0	9.2	0.1				
		TBABr	70.1	12.4	0.8				
		THABr	71.8	13.2	0.7				
		TOABr	79.8	8.2	1.3				
		TBAHSO ₄	67.2	17.2	1.5				
		TBACl	64.5	16.1	1.3				
		TBAI	61.6	11.4	1.6				
		18-Crown-6	78.8	14.3	0.4				
		MTDA	73.4	15.4	2.0		7.6		
		HdPyrBr	100						
		Ethyl bromide ²⁷		TEABr	73.1	18.1			
				TBABr	63.0	20.9			
				THABr	64.4	21.8			
				18-Crown-6	55.5	28.2			
TMBACl	70.4			16.5					
Aliquat 336	66.0			17.5					
TEBACl	66.1			14.6					
TEBABr	58.4			16.5					
TBHABr	64.2			13.6					
BTEABr	67.2			16.5					
HTEABr	73.1	12.1							
TTEABr	80.9	2.0							
HdPyrBr	86.4	0.5							

TABLE VII. Continued

Substituent	Alkyl halide	Catalyst	SPA %	N-product %	C-product %	C,N-product %	O-product %
	Benzyl chloride ¹⁷	TBAHSO ₄ ^{a,b}	20.05	20.73	24.27	20.28	1.39
		TBAHSO ₄	30.83	13.56	12.78	5.79	
		TBAI	33.57	9.60	13.66	6.05	
	Benzyl bromide ¹⁷	TBAHSO ₄	34.3	15.9	16.9	10.7	
		TBAI	25.2	10.5	18.4	13.5	
		TBACl	39.9	10.8	12.1	9.1	
		TBABr	33.7	11.7	14.1	9.8	
		TEABr	43.9	10.8	11.4	7.3	
		TBACl	37.0	12.5	43.0	6.9	
	Allyl bromide ²⁸	TBAHSO ₄	41.4	11.5	40.8	5.8	
		TBAI	24.7	6.6	50.6	6.0	
		TBACl	37.0	12.5	43.0	6.9	
		TBABr	34.8	11.8	40.6	6.2	
		TEABr	39.3	11.0	43.8	4.2	
	Phenyl ^b	Benzyl chloride ¹⁸	TEABr	22.02	72.21	1.80	
TBABr			17.48	78.99	1.98		
		TBAHSO ₄	25.93	72.00			
		TBAHSO ₄ ^a	24.38	73.33			
		TEBABr	18.56	79.13			
		TEABr	63.38	21.49			
Benzyl ^b	Benzyl chloride ¹⁹	TBACl	60.13	30.83	4.71		
		TBABr	50.04	23.87	21.36		
		18-Crown-6 ether	60.13	30.85			
		TEBABr	67.74	23.19	5.47		
4-Nitrophenyl ^b	Benzyl chloride ²⁰	TEABr	27.70	61.03	0.61		8.66
		TBABr	24.95	40.69	6.77		20.93
		TEBA	18.55	61.11	0.48		6.57
4-Chlorophenyl ^b	Benzyl chloride ²¹	TEABr	18.65	78.92			0.19
		TBABr	15.66	82.98			0.07
		TEBABr	13.96	84.69			0.07
4-Methylphenyl ^b	Benzyl chloride ²²	TEABr	18.96	78.82			0.42
		TBABr	24.75	73.07			0.54
		TEBABr	22.21	75.50			0.39

TABLE VII. Continued

Substituent	Alkyl halide	Catalyst	SPA %	N-product %	C-product %	C,N-product %	O-product %
4-Methoxy-phenyl ^b	Benzyl chloride ²²	TEABr	14.75	82.78			0.16
		TEABr ^a	18.52	80.39			0.17
		TBABr	17.40	78.65			0.07
		TEBABr	26.97	71.56			0.10

^a reflux; ^b reaction time 4 h

*Alkylation with ethyl bromide.*²⁷ A number of different quaternary ammonium salts, a crown ether, as well as phosphonium and pyridinium salts were used as catalysts in the alkylation reactions of EPA with ethyl bromide. Only the N-product was obtained in all cases except with hexadecylpyridinium bromide (HdPyrBr), where the O-product was also formed. C-product formation in alkylations with ethyl bromide as compared to alkylations with *n*-butyl bromide, can be explained by the smaller steric hindrance of the ethyl group. Further, the formation of O-products at 60 °C is due to the kinetic rearrangement of the initially formed O-product into the N-product, which is thermodynamically more stable.

In the alkylation of EPA under PTC/OH the organophilicity of the quaternary ammonium cation (quat) increases from tetraethylammonium (TEA) to tetrahexylammonium (THA); the yield of the N-product also increases, which is in accordance with Stark's mechanism. It is worthwhile to note that Makosza's catalyst, triethylbenzylammonium (TEBA) gave poorer result than the catalyst with the symmetrical quats. TEBA has proven itself to be an optional catalyst in many PTC/OH reactions which proceed by the interfacial mechanism. Similar results were obtained with similar catalysts, such as trimethylbenzylammonium (TMBA), tributylhexadecylammonium (TBHA) and methyltridecylammonium (MTDA). Moreover, when different triethylalkylammonium quats RTEA, triethylbutylammonium (BTEA), triethylheptylammonium (HTEA) and triethyltetradecylammonium (TTEA), were applied as PTC catalysts, the effectiveness of the PTC catalyst decreased with increasing length of the alkyl chain, indicating that surface active substances are poor catalysts for this type of reaction, *i.e.*, catalysts with symmetrical quats gave better results.

The influence of stirring (mixing speed) of the reactants on the yield of the N-product in the reaction was studied. A varying dependence of the yield of N-product on the agitation of the reactants was observed. Such behaviour is typical for the extraction mechanism, which is controlled by diffusion.²³

After the initial period (depending on the reaction temperature), the reaction exhibits a behavior typical of zero order reactions. This could be expected, since the reaction takes place in a solid-liquid system, where, after certain time, a layer of salt forms on the surface of the KOH, so that from that moment on the reaction can proceed only by diffusion of Q⁺OH⁻ through the formed salt layer. For such a PTC/OH system, the energy of activation is very small (less than 41.8 kJ/mol²³). According to the principles of determining mechanisms in PTC/OH systems,²³ the PTC alkylation of EPA proceeds by the extraction mech-

anism, which includes "extraction" of the hydroxide anion by the organic phase where it reacts with the substrate (EPA) producing an active organic anion which undergoes substitution reaction with the ethyl bromide to yield the final product (Scheme 10).

*Alkylation with benzyl chloride.*¹⁷ When EPA was alkylated with benzyl chloride in toluene in the presence of powdered KOH and tetrabutylammonium hydrogen sulfate (TBAHSO₄) and tetrabutylammonium iodide (TBAI), the temperature and the catalyst have a significant influence on the yield and the number of obtained alkylation products. At reflux temperature, four products were detected (N-, C-, O-, C,N-). The C-, N- and C,N-product were obtained in almost the same amounts, while the O-product was a minor product. The C-product (TBAI) and the N- and C-products (TBAHSO₄) were the main products at 60 °C. At reflux temperature, the overall alkylation proceeds with poorer results in the presence of a phase-transfer catalyst than without it but the catalysis effect was evident at 60 °C.

Three different solvents were used to ascertain the effect of solvent when the alkylation of EPA was carried out under PTC conditions: toluene, hexane, and isooctane. The N-product is the main product, then comes the C-product, the C,N-product and finally the O-product. Selective alkylation was not observed in any of the employed solvents.

*Alkylation with benzyl bromide.*¹⁷ Several quaternary ammonium salts were applied as catalysts in the reaction of the alkylation of EPA with benzyl bromide under identical conditions. The O-product was not detected, but the C-, N- and C,N-products were found. In all cases the N-product was the main product and the C,N-product was the minor product (except with TBAI).

According to the principles of determining mechanisms in PTC/OH systems,²³ the TBA catalysts (more organophilic) were better than the TEA catalyst (less organophilic) concerning the reactivity of the starting amide. This indicates that the PTC alkylation of EPA proceeds by the extraction mechanism.²⁵

*Alkylation with allyl bromide.*²⁸ Alkylation of EPA with allyl bromide under PTC/OH leads to the formation of three different products. The main product was the C-product (up to 50.6 %, GC) while the N- and C,N-products were formed in much lower quantities (~12 % and ~6 %, respectively). It seems that under these reaction conditions the carbanion center is the more nucleophilic site, which leads to the formation of the C-product as the main product. It was also found that tetrabutylammonium iodide promoted the reaction the best.

*GC-MS study.*²⁹ Phase-transfer catalyzed alkylation of *N*-ethyl-2-phenylacetamide was studied using GC-MS. *N*-Ethyl-2-phenylacetamide was alkylated using ethyl, *n*-butyl, allyl and benzyl bromide in the presence of potassium hydroxide as a base and tetrabutylammonium hydrogen sulfate as a phase-transfer catalyst in toluene at 60 °C. It was found that the reaction takes place at the nitrogen of amide group and at the α_C atom of the amide. The alkylation with ethyl bromide gave only the N-product, while with *n*-butyl bromide the N- and C-product and with benzyl and allyl bromide the N-, C- and C,N-products.

Alkylation of N-phenyl-2-phenylacetamide

N-Phenyl-2-phenylacetamide was alkylated with benzyl chloride under PTC/OH conditions using 18-crown-ether at 90 °C and only the N-product was isolated.³⁰

It has been reported that when PPA is alkylated in the presence of different phase-transfer catalysts,¹⁸ the main product was found to be again the N-product, while the C-product was found in only two cases (tetraethylammonium bromide (TEABr) and tetrabutylammonium bromide (TBABr)). All the used phase-transfer catalysts catalyze the reaction at low temperatures, while at reflux temperature the yield of the N-product of alkylation of the non-catalyzed reaction is higher than in the catalyzed reaction. More organophilic quats promoted the reaction better.

*Alkylation of N-benzyl-2-phenylacetamide.*¹⁹ When BPA was alkylated in the presence of different phase-transfer catalysts, the main product was again found to be the N-product, while the C-product was found in only three cases (tetrabutylammonium bromide (TBABr), tetrabutylammonium chloride (TBACl), and triethylbenzylammonium bromide (TEBABr)). The nature of the counter ion influences the yield of the N-product, but the more important fact is that more organophilic quats give better yields of the N-product. Triethylbenzylammonium bromide, which is not usually good for solid-liquid phase-transfer systems, gave a good yield. The obtained results indicate that the investigated phase-transfer catalyzed reactions proceed by the extraction mechanism, according to the literature.²³

Alkylation of N-(4-substituted phenyl)-2-phenylacetamide

When an electron-acceptor group, such as the nitro group, is present, besides the N- and O-product, the C-product is also formed.²⁰ The N-product is still the main product but the N/O- ratio was 1.16–9.30, thus favoring O-alkylation in comparison to the other substituents.

When CPA was alkylated under PTC/OH conditions²¹ besides the N-product, the O-product was also formed.

The benzylation of MPA and MetPA under phase-transfer conditions was performed in toluene at 60 °C.²² Once again the main product was the N-product, but the O-product was also present. The C-products were not detected at all. At higher temperature (reflux temperature), the reactivity of MPA and MetPA and the yield of the N-products were almost the same as at 60 °C.

If the rule given by Rabinowitz and coworkers²³ is applied and TEABr and TBABr are compared, it can be seen that TBABr is a slightly better catalyst for the alkylation of MPA and MetPA. This fact indicates that the phase-transfer catalyzed benzylation reaction of MPA and MetPA proceeds by the extraction mechanism proposed by Starks.²⁵ This conclusion is in agreement with the results of the benzylation of *N*-ethyl-2-phenylacetamide^{17,24,27} and *N*-benzyl-2-phenylacetamide,¹⁹ while the results of the benzylation of *N*-phenyl-2-phenylacetamide,¹⁸ *N*-(4-nitrophenyl)-2-phenylacetamide²⁰ and *N*-(4-chlorophenyl)-2-phenylacetamide²¹ indicate that these reactions proceed by the interfacial mechanism.²⁶

*Alkylation of various N-substituted 2-phenylacetamides*³¹

Various N-substituted 2-phenylacetamides (ethyl, *n*-butyl, *i*-butyl, *t*-butyl, cyclohexyl, phenyl) were alkylated with ethyl bromide under same PTC/OH conditions at 60 °C in toluene. The ratio of the N- and O-product was studied using GC. Table VIII shows the influence of substituents on the alkylation reaction and on the N/O-ratio. Steric hindrance of substituents as well as inductive and resonance effects have a great influence on the reactivity of the formed anions.

TABLE VIII. Alkylation of various N-substituted 2-phenylacetamides with ethyl bromide under PTC/OH (toluene 10 ml, SPA 5 mmol, equimolar ratio of SPA, alkyl halide and potassium hydroxide, tetrabutylammonium hydrogen sulfate 0.5 mmol, reaction temperature 60 °C, reaction time 2.5 h)

N-substituent	SPA/%	N-product/%	O-product/%	Ratio N/O-alkylation	Undef. products/%
Et	63.6	27.1	0	∞	9.3
<i>n</i> -Bu	70.0	16.0	0.1	160	13.9
<i>i</i> -Bu	69.0	11.1	0	∞	19.9
<i>t</i> -Bu	71.3	0.8	8.6	0.1	19.3
Cyclohexyl	81.2	0	7.0	0	11.8
Ph	90.0	0.5	2.3	0.2	7.2

5. FURTHER INVESTIGATIONS

According to the results obtained in the investigation of the alkylation reaction of N-substituted phenylacetamides under neutral and basic conditions, the main study in the future should be directed towards the investigation of the alkylation of N-substituted phenylacetamides, which resemble the structure of benzylpenicillin, especially N-substituted phenylacetamides where the substituents are amino acid residues. It is to be expected that cyclic and heterocyclic group substituents which have a structure similar to the structure of the heterocyclic moiety in benzylpenicillin could give interesting results, concerning selectivity.

Also, the selectivity in the alkylation reactions under neutral conditions should be improved using new catalysts and reaction conditions, in order to obtain the O-product of alkylation in higher yields and as the only product of alkylation.

SUMMARY

Various N-substituted phenylacetamides were alkylated using different alkylating agents under neutral and basic conditions. The reactions were performed at different reaction temperatures and in various solvents. Also, a variety of catalysts were used, including phase-transfer catalysts. The reactions were followed using the GC or GC-MS technique and the presence as well as the yields of the alkylation products were established.

Generally, the best yield and highest selectivity in the studied reactions were achieved under basic conditions where in certain cases some products, mostly the N-product, were obtained solely in quantitative yields.

Acknowledgment: The authors are grateful to the Ministry of Science, Technology and Development of Serbia for financial support (Project 1694).

ABBREVIATIONS

SPA – N-substituted-2-phenylacetamide
EPA – N-ethyl-2-phenylacetamide
PPA – N-phenyl-2-phenylacetamide
BPA – N-benzyl-2-phenylacetamide
NPA – N-(4-nitrophenyl)-2-phenylacetamide
CPA – N-(4-chlorophenyl)-2-phenylacetamide
MPA – N-(4-methylphenyl)-2-phenylacetamide
MetPA – N-(4-methoxyphenyl)-2-phenylacetamide
TBAHSO₄ – tetrabutylammonium hydrogen sulfate
TEABr – tetraethylammonium bromide
TBABr – tetrabutylammonium bromide
TBACl – tetrabutylammonium chloride
TBAI – tetrabutylammonium iodide
THABr – tetrahexylammonium bromide
TOABr – tetraoctylammonium bromide
TEBABr – triethylbenzylammonium (TEBA) bromide
TEBACl – triethylbenzylammonium chloride
TMBACl – trimethylbenzylammonium chloride
DMSO – dimethyl sulfoxide
PTC – phase-transfer catalysis
THF – tetrahydrofuran
HdPyrBr – hexadecylpyridinium bromide
TBHABr – tributylhexadecylammonium bromide
BTEABr – triethylbutylammonium bromide
HTEABr – triethylheptylammonium bromide
TTEABr – triethyltetradecylammonium bromide
MTDACl – methyltridecylammonium chloride
TEA – tetraethylammonium quat
THA – tetrahexylammonium quat
TEBA – triethylbenzylammonium quat
TMBA – trimethylbenzylammonium quat
TBHA – tributylhexadecylammonium quat
MTDA – methyltridecylammonium quat
RTEA – triethylalkylammonium quat
BTEA – triethylbutylammonium quat
HTEA – triethylheptylammonium quat
TTEA – triethyltetradecylammonium quat

ИЗВОД

АЛКИЛОВАЊЕ N-СУПСТИТУИСАНИХ 2-ФЕНИЛАЦЕТАМИДА

ДУШАН Ж. МИЈИН¹, МИЛИЦА М. МИШИЋ-ВУКОВИЋ¹ и СЛОБОДАН Д. ПЕТРОВИЋ^{1,2}¹Технолошко-металуршки факултет, Универзитет у Београду, Карнегијева 4, 11001 Београд и ²Хемофарм концерн, Београдски пут бб, 26300 Вршац

Различити N-супституисани 2-фенилацетамиди су алкиловани користећи различите агенсе за алкиловање у неутралној и базној средини. Реакције су извођене у различитим растварањима и на различитим температурама. Коришћени су и различити катализатори, укључујући међуфазне катализаторе. Реакције су праћене употребом GC и GC-MS техника. Најбољи приноси као и селективност остварени су при алкиловању N-супституисаних 2-фенилацетамиди у базној средини при чему је N-производ настао у скоро квантитативном приносу.

(Примљено 24. фебруара 2004)

REFERENCES

1. B. C. Challis, J. A. Challis, in *The Chemistry of Amides*, Interscience Publishers, London, 1970, p. 731
2. S. D. Petrović, N. D. Stojanović, D. Ž. Mijin, *Hem. Ind.* **50** (1996) 456
3. S. D. Petrović, N. D. Stojanović, O. K. Stojanović, N. L. Kobilarov, *J. Serb. Chem. Soc.* **51** (1986) 395
4. S. D. Petrović, N. D. Stojanović, O. K. Stojanović, N. L. Kobilarov, *J. Serb. Chem. Soc.* **53** (1988) 633
5. B. C. Challis, A. D. Frenkel, *J. Chem. Soc. Perkin Trans. II* (1978) 192
6. S. D. Petrović, N. D. Stojanović, O. K. Stojanović, N. L. Kobilarov, *J. Serb. Chem. Soc.* **55** (1990) 575
7. A. W. Chapman, *J. Chem. Soc.* **127** (1925) 1992
8. A. L. Garner, G. C. McCarty, *The Chemistry of Amidines and Imidates*, S. Patai, Ed., Interscience, New York, 1975, p. 190
9. D. G. Antonović, D. Ž. Mijin, N. D. Stojanović, Lj. A. Jeremić, S. D. Petrović, *J. Serb. Chem. Soc.* **59** (1994) 967
10. H. Muxfeldt, J. Behling, G. Grethe, W. Rogalski, *J. Am. Chem. Soc.* **89** (1967) 4991
11. R. Kantlehner, *Advanced Org. Chem.* **9** (1979) 181
12. S. D. Petrović, N. D. Stojanović, Lj. A. Jeremić, M. B. Blagojević, *J. Serb. Chem. Soc.* **60** (1995) 749
13. C. Wong, L. M. Jackman, R. G. Portman, *Tetrahedron Lett* **11** (1974) 921
14. P. Beak, Jae-Kem Lee, B. G. McKinnie, *J. Org. Chem.* **43** (1978) 1367
15. S. D. Work, D. R. Bryant, C. R. Hauser, *J. Org. Chem.* **29** (1964) 722
16. K. Sukata, *Bull. Chem. Soc. Jpn.* **58** (1985) 838
17. D. Ž. Mijin, B. M. Božić, N. D. Stojanović, S. D. Petrović, *J. Serb. Chem. Soc.* **61** (1996) 1137
18. D. Ž. Mijin, B. M. Božić, D. G. Antonović, N. D. Stojanović, S. D. Petrović, *J. Ind. Chem.* **36B** (1997) 934
19. D. Ž. Mijin, B. M. Božić, V. D. Janković, D. G. Antonović, N. D. Stojanović, S. D. Petrović, *J. Serb. Chem. Soc.* **64** (1999) 83
20. V. D. Janković, D. Ž. Mijin, S. D. Petrović, *J. Serb. Chem. Soc.* **67** (2002) 373
21. D. Ž. Mijin, V. D. Janković, S. D. Petrović, *J. Serb. Chem. Soc.* **68** (2004) 85
22. D. Ž. Mijin, V. D. Janković, S. D. Petrović, *Nauka, Tehnika, Bezbednost* **1** (2004) 29 (in Serbian)
23. M. Rabinovitz, Y. Cohen, M. Halpern, *Angew. Chem. Int. Ed. Engl.* **25** (1986) 960
24. D. Ž. Mijin, N. D. Stojanović, S. D. Petrović, *J. Serb. Chem. Soc.* **59** (1994) 811
25. C. Starks, *J. Am. Chem. Soc.* **93** (1971) 195
26. M. Makosza, *Pure Appl. Chem.* **43** (1975) 439
27. D. Ž. Mijin, M. M. Mišić-Vuković, N. D. Stojanović, S. D. Petrović, *Ind. J. Chem.* **35B** (1996) 1201
28. D. Ž. Mijin, N. D. Stojanović, S. D. Petrović, *Zh. Org. Khim.* **34** (1998) 1876
29. D. Ž. Mijin, D. G. Antonović, V. V. Vajs, S. D. Petrović, *Nauka, Tehnika, Bezbednost* **2** (1997) 45 (in Serbian)
30. G. O. Torossian, S. A. Grigor, G. Gekchyan, A. T. Babayan, *Arm. Khim. Zh.* **37** (1984) 740
31. D. Ž. Mijin, N. D. Stojanović, S. D. Petrović, *Zh. Org. Khim.* **34** (1998) 1578.